



UM-SERIES USER GUIDE

True Diversity Wireless System

Customer Service Hotline: 400-707-68
Guangzhou Ruifeng Digital Technology Co., Ltd.
TEL: +86 2039280388
FAX: +86 2039280123
E-mail: lax@lax-pro.com
[Http://www.lax-pro.com](http://www.lax-pro.com)

1 year warranty

When you, a noble customer, purchased any series of LAX products from our authorized dealer, since then, you will receive a 1-year warranty commitment from LAX. Please keep your invoice or receipt properly. Because that's the credentials of the buyer and supporting documents at the time of warranty. In this year, due to the defects of components or the transportation process, your LAX products have been sold out if the current performance does not meet our published standards or has quality problems, you can get warranty from LAX authorized service center (free of parts fee and maintenance fees), and we apologize for the inconvenience.

Warranty restrictions

The company will provide maintenance services for any components that need to be replaced due to quality reasons (except for quality problems in the warranty restrictions). When your product is handed over to an authorized service center for warranty, we will try our best to repair your product in the shortest possible time. and get back to you as soon as possible. We apologize for any inconvenience caused.

Warranty service

The company will provide maintenance services for any components that need to be replaced due to quality reasons (except for quality problems in the warranty restrictions). When your product is handed over to an authorized service center for warranty, we will try our best to repair your product in the shortest possible time. and get back to you as soon as possible. We apologize for any inconvenience caused.

Terms of service

When your product needs repair service, please be sure to write or call the address of the repair center or authorized dealer to ask how to send the product that needs warranty to the authorized repair center or repair factory. After you purchase any series of products from our company, please keep the product packing box and accessories in a safe place so that you can use them when you need to mail or transport them. But you have to pay for the postage or car or transportation for the warranty product yourself.

If you are not satisfied with the products repaired by our service center, you can contact the head office or the general agent in the area where the customer is located. If the product still has quality problems after many replacement parts or repairs, you can choose to refund, and we will return the money you purchased the product to you. However, the payment does not include transportation costs, transportation costs, interest on payment, insurance premiums, product accessories and other decorative costs. If a refund is required, you must also get written confirmation from the service center that it is not one of the warranty limitations.

Component changes

The company reserves the right to make changes to all or part of the parts of the product, and give priority to the parts of the latest version of the product during the warranty period, so as to provide you with more powerful and higher-performance products. If the product you purchased has been discontinued during the warranty period, we will have to provide you with the latest parts, please forgive me.

Declaration of accidental damage

You, a valued customer, will not be compensated by LAX for other losses incurred directly or indirectly due to equipment damage.
Hereby declare!

Warranty change statement

This warranty is protected by law and no one is authorized to expand, modify or revise its contents. The scope of this warranty will not be extended with the time you use the company's products. Free repairs are only available for your product before it expires. Products beyond the warranty period will be charged a reasonable fee.

This Warranty Statement supersedes the instructions in other guides



产品合格证 CERTIFICATE

型号 (Model)

质检员 (QA)

日期 (DATE)

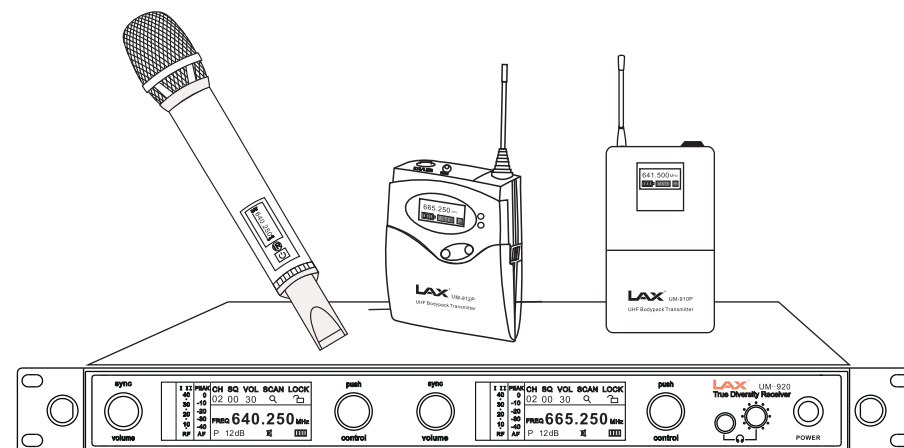

Manufacturer's Statement

User's Guide is for informational purposes only and subject to change without notice.

Contents

1 year warranty.....	1
Manufacturer's Declarations.....	2
Contents.....	3
Important Safety Tips.....	4
Professional wireless series.....	5
Receiver Overview.....	6
Overview of the displays.....	7
Synchronously adjust transmitter and receiver frequencies.....	8
Receiver function icons.....	9
Changes the frequency bank and channel.....	10
Adjust receiver volume.....	11
Temporarily lock the receiver function key.....	12
Adjusts the transmission power.....	13
Mute.....	13
Battery level	13
Overview of handheld transmitters.....	14
UM-910H Install the battery and change microphone head.....	15
Overview of the UM-912P bodypack transmitter.....	16
UM-912P bodypack transmitter Installing Batteries.....	17
Overview of the UM-910P bodypack transmitter.....	18
Putting the devices into operation.....	19
UM-920 Connecting an amplifier/mixing console UM-920.....	20
Specifications.....	21
The machine is packed with the following accessories.....	22

LAX® Warranty Card

Dear user:

LAX product which produced by RUIFENG Corporation (RUIFENG in brief) are ensured with high quality by strict quality inspection and control before delivery.RUIFENG will provide warranty according terms mentioned in this warranty card.The warranty is void if warranty card or purchasing invoice is missed.The service is suggested to start by calling our service No:(86 20)3928 0338 in advance.

Warranty Terms And Conditions

- A. This warranty is valid within one year from date of sale (except some occasions specially mentioned as below), and covers for manufacturing defects and all matters concerning the workmanship of LAX products.
- B. Warranty period for particular item.
 1.Offering one month free change service and one year warranty for amplifiers, mixers or processors.
 2.Offering three month warranty for which categorized as spare parts:
 1). The voice coil and diaphragm of microphone.
 2). The voice coil and diaphragm of speaker.
- C. RUIFENG will not be responsible for any warranty if / for:
 1). The product is not distributed by RUIFENG or RUIFENG authorized dealers/distributors. 2). Fake products.
 3). Products without intact serial number or serial number is changed, deleted or transferred or has not been recorded in the company's record. 4). No security label.
- D. The warranty becomes void if product problems result from.
 1). Improper operation and misuse (overloading or burned with feedback). 2). Careless moving.
 3). Terrible conditions (over-high input voltage and humidity). 4). Irresistible situation such as STORM or EARTH QUAKE...etc. 5). Repaired or responsible by unofficial technicians outside RUIFENG. 6). Failure assemble/installation from the instruction of manufacturer.
- E. The warranty applies only on the cost of repair or replacement and does not include the relevant freight charges.
- F. RUIFENG is not responsible for the loss caused by equipment or component damaging.
- G. RUIFENG charges reasonably if warranty period expired.
- H. The warranty card is subject to change without prior notice.

Purchaser Name :	Manufacturer :
<input type="text"/>	<input type="text"/>
Dealer Name :	Dealer Address :
<input type="text"/>	<input type="text"/>
Purchase Date :	Model :
<input type="text"/>	<input type="text"/>
Serial No. :	Invoice No. :
<input type="text"/>	<input type="text"/>

Tel: 020-39280338 Fax:020-39280123 E-mail: lax@lax-pro.com Http: www.lax-pro.com
 ADD: No. 10, Shilou Section, Shilian Road, Shilou Town, Panyu District, Guangzhou ,China
 Note : Please retain this for your records

Important Safety Tips

Equipment system

*Please read this instruction carefully.

*Please keep the instructions properly. Always hand the device and external power adapter along with instructions to a third party user.

*Please use only the additional equipment and accessory parts recommended by our company.

*All maintenance work must be carried out by specially trained maintenance personnel.

*When the equipment or the external power adapter is damaged in any form, when liquid or foreign matter penetrates into the equipment or the external power adapter or the equipment is wet, when the equipment can not work normally or shut down, maintenance work must be performed.

*Warning: Do not use the device or external power adapter near water. Do not use the device or external power adapter in the rain or wet environment. Danger of fire and electric shock.

*Use only the external power adapter provided with it.

*Remove the external power adapter from the socket to disconnect the device from the power supply if:

1. There is a storm.

2. A long time do not use the equipment.

*Attention should be paid to external power adapter.

1. In good condition and somewhere easy to find.

2. Plug tightly into the socket when in use.

3. Use only within the permissible temperature range.

4. Avoid being covered by other objects or exposed to the sun for a long time to prevent excessive temperature.

*Please do not cover the vents. Install the device according to the instructions.

*Do not place equipment and external power adapters near heat sources, such as radiators, heat drains, ovens or other devices (including loudspeakers).

*Ensure that the external power adapter does not overload the connected socket or extension cable. Otherwise, there is a risk of fire or electric shock.

Professional wireless series

Professional wireless series products are composed of the most advanced and modern high-frequency transmission equipment, which is not only safe and reliable, but also easy to use and comfortable. Each transmitter and receiver can achieve high quality wireless audio transmission.

The UHF band has seven different frequency ranges for audio transmission, with up to 1000 arbitrary frequencies in each range. The equipment can be selected in the following frequency true range.

The frequency band system

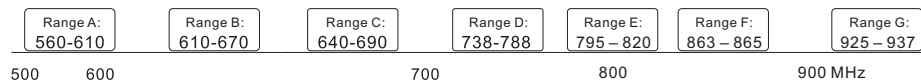

- >Each frequency range (A-B...E) has 1 channel library, each channel library has 100 set frequencies, and there is a maximum of 1000 free set frequencies.
- >The frequency range(F) has 1 channel library, the channel library has 16 set frequencies, and there are up to 80 adjustable frequencies.
- >The frequency range(G) has 1 channel library, the channel library has 32 set frequencies, and there are up to 480 adjustable frequencies.

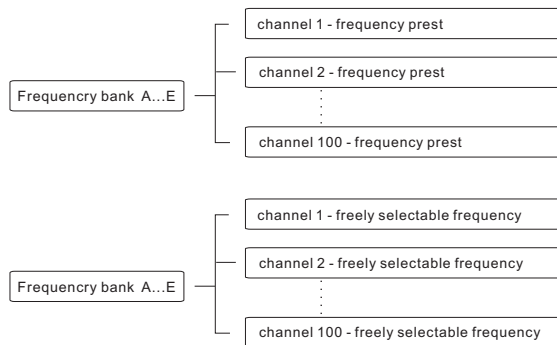

- >In channel libraries "1" to "E", each channel is equipped with a preset frequency library at the factory. The preset frequency cannot be changed.
- >You can view all preset frequencies in the frequency data sheet (within the scope of supply).
- >The frequencies in channel library "A" to "E" can be set and saved freely. There may be intermodulation interference between these frequencies.

The machine is packed with the following accessories

1. Antenna ×1
2. Power adapter ×1
3. Operating manual ×1
4. warranty card ×1
5. AA size batteries ×4
6. Audio double plug cable ×1

Specifications

System

Receiving frequency range.....	UHF630MHz~937MHz
Modulation.....	wideband FM
Oscillation.....	PLL synthesized
Receiving frequencies.....	2000 frequencies, tuneable in steps of 25 kHz factory-preset with 200 fixed-frequency
Frequency stability.....	$\pm 0.005\%$
Switching bandwidth.....	50MHz
Max frequencies deviation.....	$\pm 68K$
Receiver principle.....	auto select (true diversity
Receiver sensitivity.....	-100dBm
THD	$\leq 0.5\%$
Frequency response.....	50Hz~18KHz
Operating disdance.....	linea distance 100M notice : actual range depend on absorb, reflect and disturb of the radio frequency signal

Receiver characteristics

Antennas input.....	TNC/ 50 Ω
IF frequency.....	quadratic conversion (110MHz,10.7MHz)
Pilot frequency mode.....	digital pilot frequency
Squelch.....	digital pilot frequency and doble noise control
Sensitivity	-90dBm to -100dBm
Adjacent channel rejection	$\geq 75dB$
Max. output level.....	+10dBV
Audio output level.....	balance type: 2. 2V (open type) THD $\leq 0.5\%$ non balanced: -4dBV/1K
Input impedance	40KHz,unbalanced 1M Ω
Power supply.....	DC 12V~16V
Current consumption	350mA

Handhold / bodypack transmitter

Antenna.....	inside the bodypack
Output power.....	>10mW
Out put current.....	< 110mA
S/N ratio THD	< -60dB
Frequency adjustment.....	IR frequency locked automatically
Frequency response	microphone / 50Hz~18KHz ,Line / 40Hz~20KHz
Max. audio deviation	$\pm 68KHz$
Batteries.....	DC 1. 5V*2 (AA batteries)

Receiver Overview

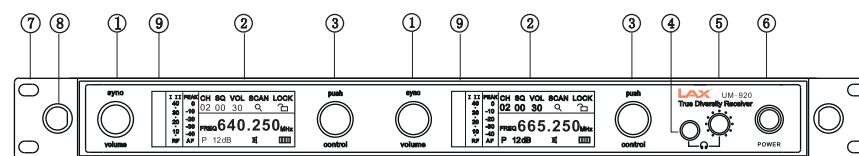

Front operating panel

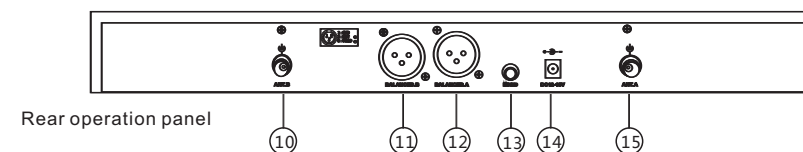

Rear operation panel

- (1) Shuttle knob: press to enter SYNC mode, transmit frequency and Encryption & Decryption information to TX; The volume can be quickly set by rotating in the clockwise or counterclockwise direction.
- (2) LCD display window display all operational information.
- (3) Shuttle knob: press to select the setting project in the direction of clockwise and counterclockwise rotation to set new parameters.
- (4) Monitor earphone output socket: can be connected to stereo earphone, monitor the output signal. (optional)
- (5) Earphone volume adjustment knob: the volume of stereo earphone can be adjusted clockwise and counterclockwise.
- (6) Power switch: Turn on and off the power supply in the machine. When the power switch is turned on, the LCD screen will be lit
- (7) Cabinet fixing Angle hole: used to fix the receiver on the 19-inch standard cabinet.
- (8) Front antenna connection seat hole: Attachment can be installed to extend the antenna seat, connect the wire to the antenna seat on the rear panel.
- (9) Infrared data transfer window
- (10) TNC interface: antenna input port 2 (ANT.B)
- (11) Audio output (AF OUT BAL),XLR-3M socket,balanced A . The sensitivity of the balanced output signal is equal to the sensitivity of the Dynamic Cardioid Microphone head
- (12) Audio output (AF OUT BAL),XLR-3M socket,balanced B . The sensitivity of the balanced output signal is equal to the sensitivity of the Dynamic Cardioid Microphone head
- (13) Audio output (AF OUT UNBAL),1/4"(6.3mm) jack socket,unbalanced
- (14) DC socket : Aadapter supply power to the receiver jack.
- (15) TNC interface: antenna input port 1 (ANT.A)

Overview of the displays

The standard display information includes the working status of the receiver and the important information received from the transmitter (assuming the transmitter supports this feature).

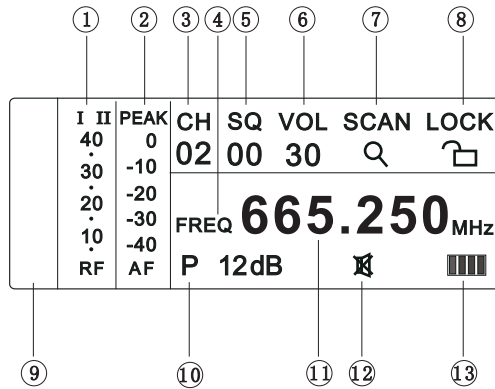

Show meaning

- ① Radio frequency signal level
- ② Demodulated audio signal output level
- ③ Work channel
- ④ Manual frequency modulation function
- ⑤ Receiving sensitivity adjustment
- ⑥ Receive volume control
- ⑦ Automatic frequency search function
- ⑧ Panel lock, set, and unlock
- ⑨ Infrared data transfer window
- ⑩ Transmitter high and low power control
- ⑪ Working frequency
- ⑫ Output is muted
- ⑬ Emitter power display

UM-920 Connecting an amplifier/mixing console

Attention! The receiver has 2 independent XLR output jacks. Unbalanced 1/4" (6.3mm) jack connected in parallel with 2 XLR ports

> Use a suitable cable to connect the amplifier and/or the mixing console to the XLR-M socket ⑪, ⑫, or the unbalanced jack socket ⑬.

> Please you adjust the audio output level of the receiver to the input of the amplifier or mixing console. Avoid amplifier or mixer overload distortion.

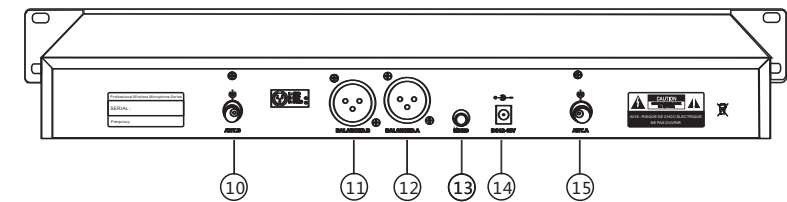
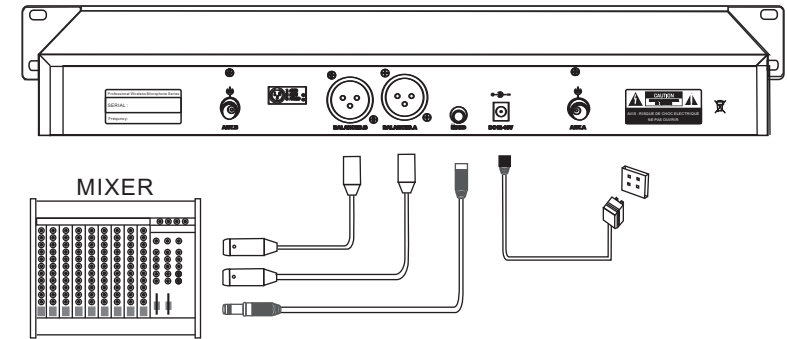

- ⑩ Antenna input B
- ⑪ Audio output B (BAL)
- ⑫ Audio output A (BAL)
- ⑬ A+B mixed output (UNBAL)
- ⑭ DC socket
- ⑮ Antenna input A

Putting the devices into operation

UM-920 receiver

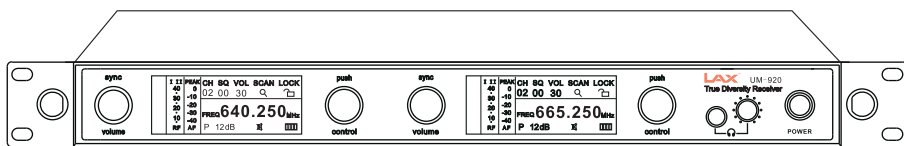

- > You can place the receiver on a solid surface or mount it into a 19" rack.
- > It is advisable to place the receiver at least 1M above the ground
- > Please keep a distance of at least 1 meter between the transmitter and the receiving antenna when using, in order to obtain better signal reception effect.

Connecting the rod antennas(See below)

- > Attach the included antennas to the back of the receiver
- > Align the antennas in a V-shape.

> Attention!

- A. The supplied rod antennas are suit able for use in good reception conditions.
- B. You have the following options to improve the sensitivity of the received signal
 - > You can use the optional antenna front assembly kit, and install the rod antenna to the front of the receiver
 - > When using more than one receiver, We reconmend that you can use our antennas distribution system UM-88D(It is optional and must be purchased separately)

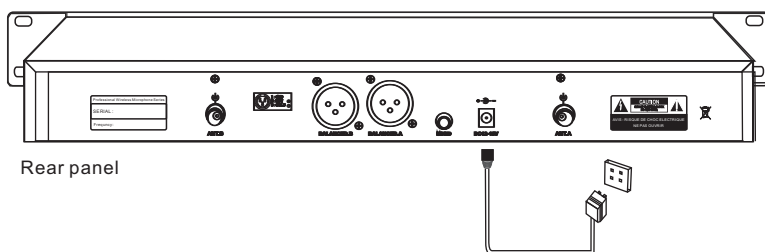

Rear panel

Connecting the mains unit (See above)

- > Only use the supplied mains unit. It is designed for the receiver and ensures safe operation.
- > Connect the power supply to the receiver and plug the cord into an AC power source.

Synchronously adjust transmitter and receiver frequencies

Each time the Sync key is pressed, the receiver will send a random transmission code data, the currently set carrier frequency data and the control data of transmit power to the transmitter in the infrared transmission mode. (The frequency, power and transmission code of the transmitter are all set by the receiver)

Job-dial ① : Controls data transmission and receiver volume adjustment.

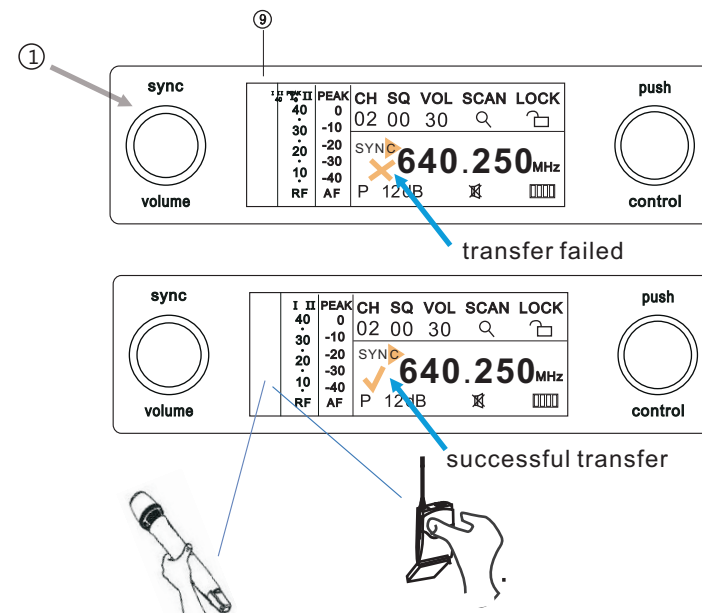

To transfer the parameters

- A. Turn on the transmitter and receiver.
- B. Press Sync button ① on the receiver to start parameter transmission
- C. The receiver screen shows SYNC and flashes
 - > place the infra-red interface ⑤ of the handheld transmitter (See page 14) or the infrared interface of the body pack transmitter ⑤ or ⑦ (See page 16 or 18) in front of the infrared interface ⑨ of the receiver.
 - > The parameters are transferred to the transmitter. When the transfer is completed, "✓" appears on the display panel. The receiver then switches back to the current standard display.
 - > When the receiver screen displays "X", synchronous transmission fails. Then the receiver returns to the current standard display state. Press Sync button ① again and transmit data again until success

▲ When synchronously adjusting the data of the transmitter and receiver, the IR icon of the transmitter should be aligned with the infrared data transmission port ⑨ of the receiver, and the distance between the two should be about 30cm.

Receiver function icons

You can select the function icon by simply turning the Jog-dial ③ in the standard display state. Each icon corresponds to a function.

Jog-dial ③ : Function selection menu.

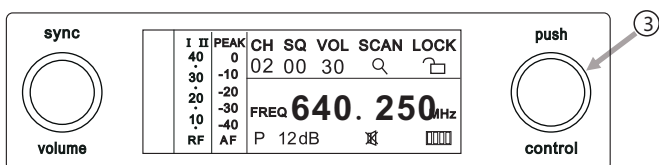

There are 7 icons on the receiver display, corresponding to functions. Turn the Jog-dial ③ to function icon, you can modify the parameters of the corresponding function.



LCD full screen display function icons

Modify the parameters corresponding to the function icons

- Rotate the jog-dial, and the cursor will cycle through the icons corresponding to each function. If you need to change the function parameters corresponding to the icons, please press and rotate the jog-dial ③ to change the parameters. After modifying the parameters, Press the jog-dial again to finally save the required parameters.
- Hold the cursor on the selected function icon and press the shuttle knob to enter the state of changing the corresponding function parameters.
- The cursor stays on the icon of the selected function. If the shuttle knob is not operated within 5 seconds, the cursor will stop blinking automatically give up changing the setting and save the parameters of the current setting. You can also press the shuttle knob directly, the cursor will stop blinking, and the receiver will automatically save the current set parameters

Tip: For more details on the function icons, please refer to the respective instruction guides for the function icons (see pages 10 to 18)

Overview of the UM-910P bodypack transmitter

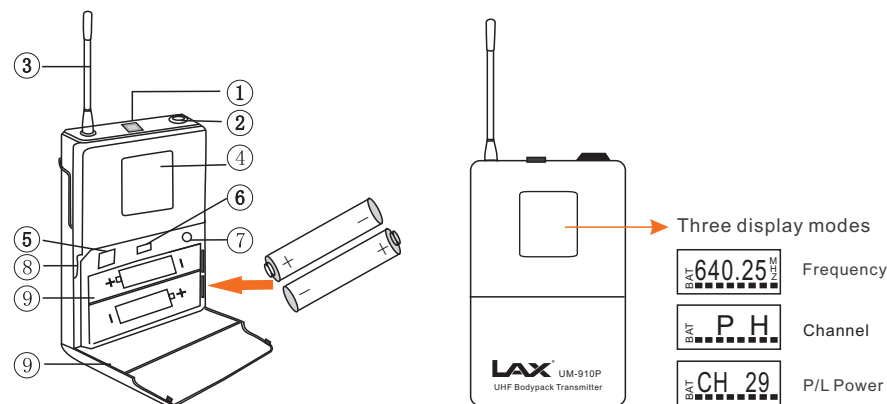

Operating components

- ON/OFF ON/OFF button
- Microphone/instrument input, XLR jack socket
- Antenna
- Display panel, backlit in orange
- Infra-red interface
- RF power bit switch
- Adjust the sensitivity of the microphone/line input.
- Battery compartment
- Battery compartment cover

connecting the microphone cable/instrument cable

- > The audio input is designed for the connection of both condenser microphones and instruments (eg : guitars)
- > The electrets capacitor microphone is powered by a DC power supply through a cannon input port
- > Use one of the recommended microphone or the optional instrument cable.
- > Insert the plug of the microphone or instrument cable in to the XLR jack ②.

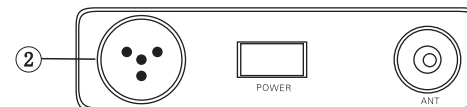

UM-912P bodypack transmitter Installing Batteries

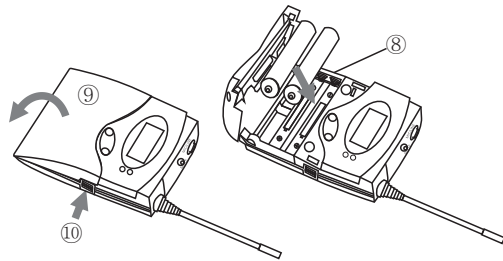

A. For powering the bodypack transmitter, you can either use two 1.5 V AA size batteries

- > Push the two catches ⑩ in the direction of the arrows and open the battery compartment cover ⑨.
- > As shown in the figure above, load the battery into the battery compartment ⑧.
- > Observe correct polarity when inserting the batteries
- > Close the battery compartment ⑧
- > The battery compartment cover ⑨ locks into place with an audible click

B. connecting the microphone cable/instrument cable

- > The audio input is designed for the connection of both condenser microphones and instruments (eg. guitars).
- > DC powering of the condenser microphones is via the audio input.
- > Use one of the recommended microphone or the optional instrument cable
- > Connect the 3.5mm jack plug ⑬ from the microphone or instrument cable to the 3.5mm jack socket MIC/LINE ①
- > lock the jack plug by screwing down the coupling ring of the cable
- > Via the operating menu, adjust the sensitivity of the microphone /line input

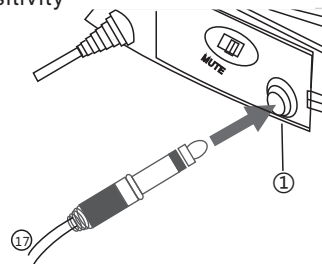

Changes the frequency bank and channel

CH This is the channel library function icon, used to set the receiver operating frequency. Each receiver has 2 channel libraries for a total of 200 channels (200 frequencies)

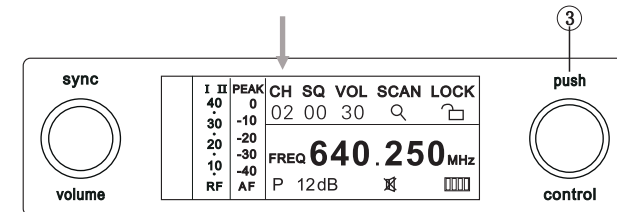

To change the channels

- A. Turn on the receiver
- B. Select the jog dial ③ and hold the cursor at CH.
 - > Press the jog dial ③. The channel is displayed in flash, indicating that "CH" enters the waiting state.
 - > Turn the Jog dial ③, and the frequency changes with the channel.
 - > Press the Jog dial ③ to save the current set frequency.

Attention! After the receiver finishes modifying the working frequency, the receiver and the transmitter need to be adjusted synchronously (completing the frequency matching) to work normally.

Adjusts the squelch threshold

SQ This is a function icon for the squelch. It is used to set the squelch, which can be adjusted from 00 to 10. **SQ** factory parameter value: 00.

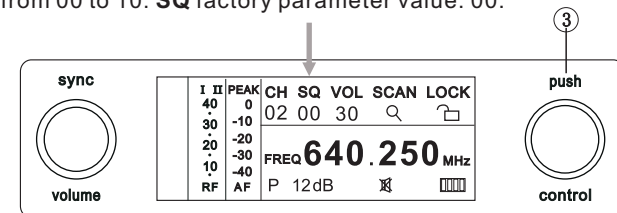

To adjust the squelch

- A. Turn on the receiver.
- B. Select the jog dial ③, and hold the cursor at SQ
 - > press the jog dial ③, the squelch threshold flag flash.
 - > Turn the jog dial ③ to modify the squelch threshold and adjust the range 00 to 10
 - > The receiver screen displays the set squelch threshold.
 - > Press the jog dial ③ to save the current set squelch threshold.

Adjust receiver volume

VOL This is the function icon of the receiver to adjust the volume output. The adjustment range is 00 to 30

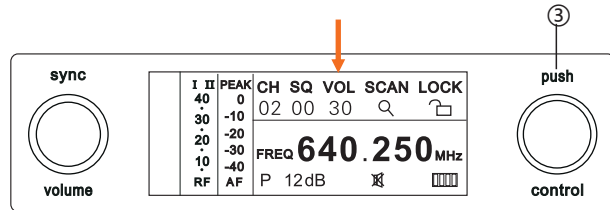

Method for modifying volume parameters

A. Turn on the receiver

B. Select the jog dial ③ and hold the cursor at **VOL**.

- > Press the jog dial ③. When the volume parameter flashes, it enters the waiting state.
- > Turn the jog dial ③. Sets the volume output value.
- > The receiver screen displays the set volume.
- > Press the jog dial ③ to save the current volume setting

battery status indicator

Automatically search for available frequencies

SCAN This is the function icon for searching unused frequencies. It is used to automatically search unused frequencies and save them.

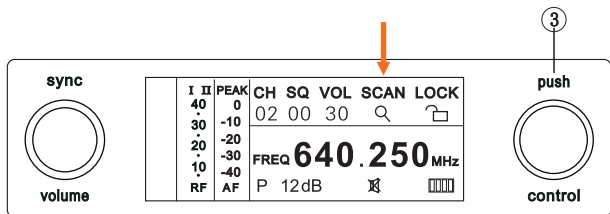

To scans for unused frequency

A. Turn on the receiver

B. Turn the jog-dial ③ to hold the cursor at **SCAN**

- > Press jog-dial ③. Start a frequency search.
- > The receiver screen displays "CH" and "frequency", changing synchronously.
- > Automatic search stop, find the unused frequency, and automatically save

Overview of the UM-912P bodypack transmitter

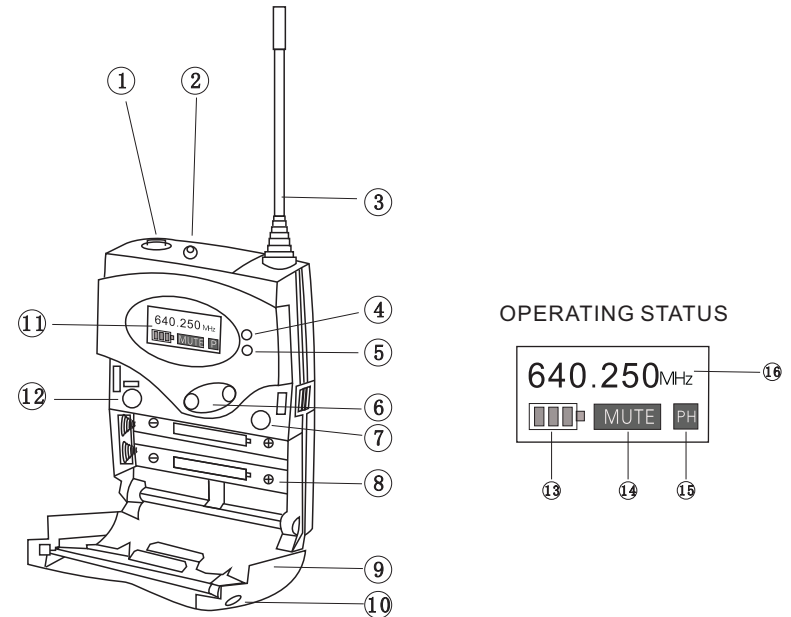

Operating component

- ① Microphone/instrument input (MIC/LINE), 3.5mm jack socket, lockable
- ② MUTE switch
- ③ Antenna
- ④ Operation and battery status indicator, red LED (lit=ON/flashing=LOW BATTERY)
- ⑤ Display the RF power with yellow Luminous Diode (lit=RF HIGH POWER)
- ⑥ ▲/▼ rocker button (UP/DOWN). The circular selection button can adjust the sensitivity of the MIC/ LINE input
- ⑦ Infra-red interface
- ⑧ Battery compartment
- ⑨ Battery compartment cover
- ⑩ Battery cover release button
- ⑪ Orange backlit display
- ⑫ ON/OFF button
- ⑬ Battery status
- ⑭ Microphone or line input is muted
- ⑮ Transmitter power display (PL=low powers, PH=high power)
- ⑯ Current signal transmitting frequency

UM-910H Install the battery and change microphone head

Install the battery

- A. The hand-held transmitter is powered by two 1.5V batteries of model AA.
- B. Unlock: Rotate the unlock ring ⑦ of the handheld transmitter in the direction of the arrow (counterclockwise), and then push the battery box cover ③ upward to remove the battery box cover. Place the battery as directed on the battery case. Please pay attention to the positive and negative terminals of the battery
- C. Close the battery cover ③: Put the battery cover into the tube slot, push the battery cover ③ downward, and turn the unlocking circle ⑦ clockwise to lock the battery cover.

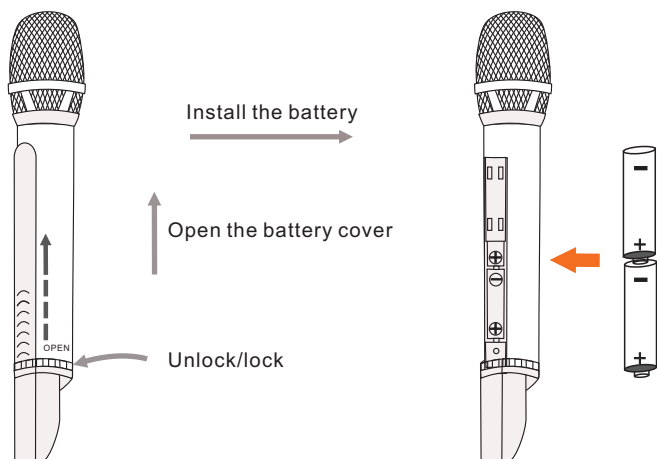

Changing the microphone head

- > The microphone is easy to change.
- > Unscrew the microphone head
- > Screw the desired microphone head to the wireless microphone
- > Re-enable the wireless microphone

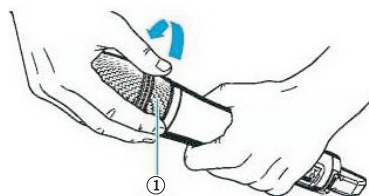

Temporarily lock the receiver function key

LOCK The function icon of the automatic key lock, which is used to close or activate the operation functions of the jog dial ① and ③

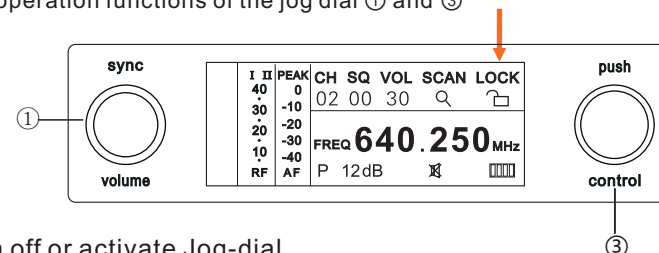

To Turn off or activate Jog-dial

- A. Turn on the receiver
- B. Turn the jog dial ③ and hold the cursor at **LOCK**
 - > Press the jog dial ③
 - > Receiver screen shows "🔒", Jog-dial ① or ③ operation function is turned off.
 - > The receiver screen displays "🔓", and the jog dial ① or ③ operation function is activated.

Manually set the receiver frequency

FREQ This is the manual change frequency function icon, used to set the frequency that the frequency library does not have.

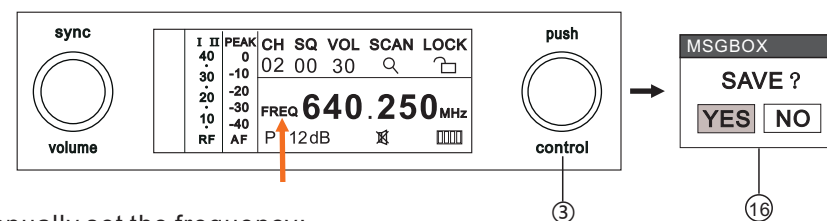

Manually set the frequency:

- A. Turn on the receiver
- B. Select the jog dial ③ and set the cursor to **FREQ**
 - > Press the jog dial ③, the screen shows the current frequency 640.25mhz and flash.
 - > Turn the jog dial ③, and the screen shows that the frequency of 640.25mhz changes with a step of 25KHz
 - > After setting the frequency, press the jog dial ③, the receiver screen shows ⑩.
 - > Use the jog dial ③ to confirm YES or NO
 - ➔ Select "YES" to save the set frequency. The "--" symbol shows below the CH icon
 - ➔ Select "NO" not to save the set frequency, restore the previous setting.

Attention! After the receiver changes the operating frequency, the receiver and the transmitter need to be adjusted synchronously to work properly.

Adjusts the transmission power

P Function icon of transmit power, used to adjust the transmit power of the transmitter.

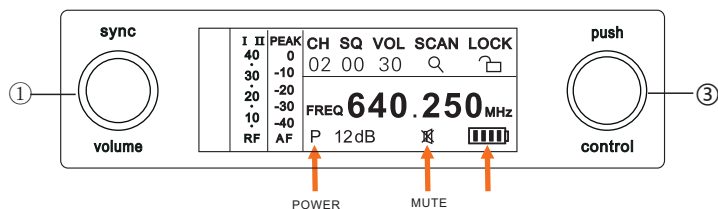

To adjust power

- Turn on the receiver
- Turn the jog dial ③, Let the cursor stay at " P "
- Press the jog dial ③, The screen displays 12dB or 0dB, 2 data is changed alternately, and the receiver will automatically save the data
- Press the job dial ①. The receiver and the transmitter synchronously adjust the data, and the transmitter completes the power modification.

Attention! After the transmitter changes the transmit power, the transmitter and receiver display the same power synchronously after the "SYNC" operation (Synchronously adjust receiver and transmitter) is performed. The transmitter transmits the new power and the setting of the changed power is completed.

🔇 Audio output is muted when this icon is displayed on the screen

Mute is the receiver has no audio signal output

- > The system is in standby state, the screen shows " 🔇 "
- > The receiver does not receive the signal from the transmitter, and the screen shows " 🔇 "

🔋 Battery level, displayed simultaneously on receiver and transmitter

The battery display at the transmitter is monitored in real time

- > When the receiver detects the transmitter signal, the receiver immediately displays the battery level
- > When the battery is about to run out, The display shows " 🔋 "

Transmitter battery status

- 🔋 approx. 100%
- 🔋 approx. 50%
- 🔋 approx. 25%. To replace the battery as soon as possible
- 🔋 Battery is about to run out

Overview of handheld transmitters

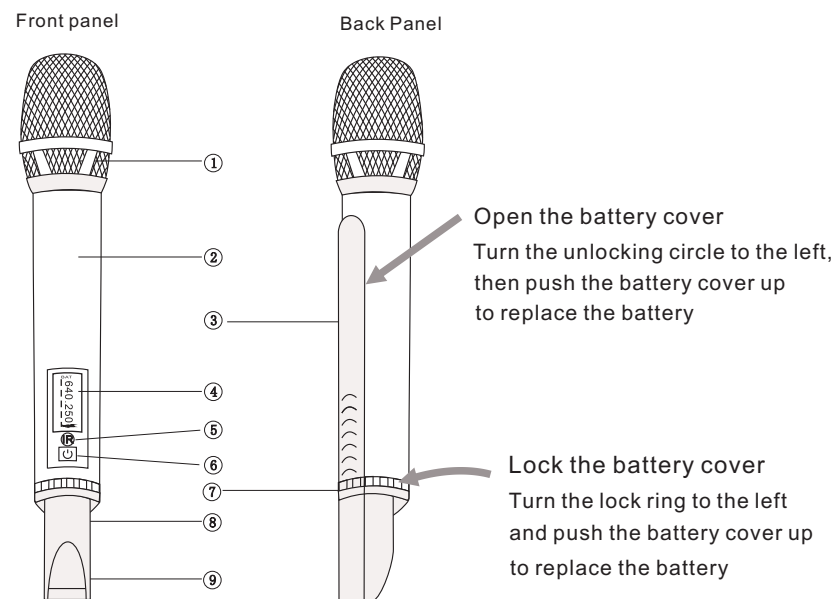

Operating elements

- Microphone head (interchangeable)
- Body of radio microphone
- Battery compartment cover
- Operation and battery status display.
3 modes (frequency, power and channel) appear on the display screen when ON/OFF is pressed circularly.
- Infrared signal interface
- ON/OFF button
- Fixed ring lock of the battery cover
(controls the unlocking or closing of the battery cover)
- Antenna
- Color marking

Three display modes

